

iCellTech Corp.

904 Gayang Techno Town 1487 Gayang 3 dong
 Gangsuh Gu Seoul 157-793 Korea
 TEL: 82-2-3665-6962 FAX: 82-2-6735-6965
 WebSite : <http://www.icelltech.com>
 E-Mail : sales@icelltech.com

Model : 13 Platinum Engineering Data sheet

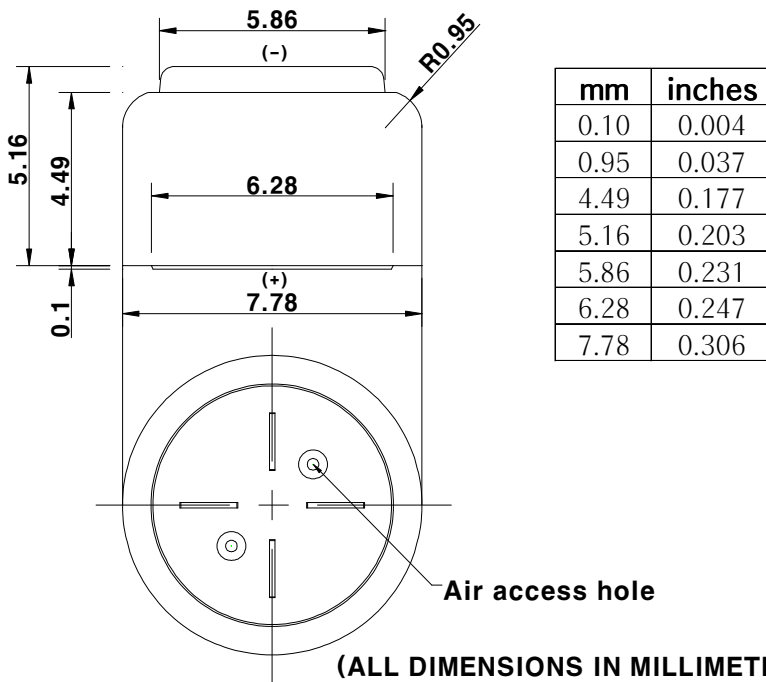

SPECIFICATIONS

Nominal Voltage :	1.4V
Rated Capacity :	310mAh
	(at 3000Ω 25℃ 50%)
Average weight :	0.82g
Volume :	230mm ³
Operating Temp :	0℃ ~ 50℃
Impedance :	≤8Ω (at AC 1KHz)
Limiting current :	3mA at 1.1V
IEC :	PR48
Terminals :	FLAT

DISCHARGE CHARACTERISTICS (25℃ 50%) (Discharged 16 hours/day)

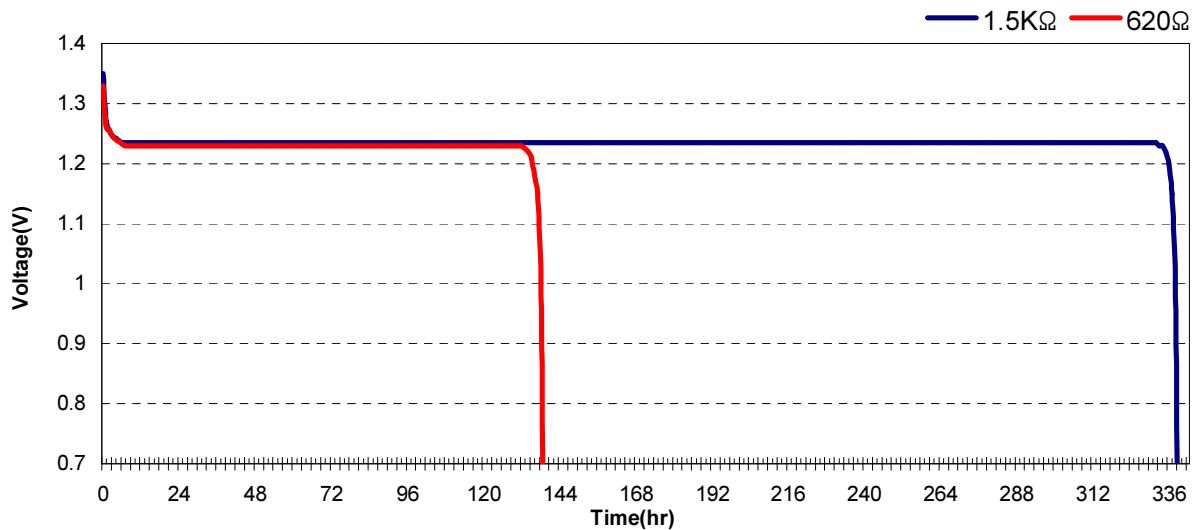

Important Notice

This data sheet contains information specific to batteries manufactured at the time of its publication

Contents herein do not constitute a warranty.

Copyright iCellTech Corp. – All Rights Reserved